

Installation instructions for Regis WS238

SAVE THESE INSTRUCTIONS
This product is ETL listed and suitable only for indoor dry locations
and approved for use at any height above the finished floor.

stone
LIGHTING

- 1 Remove glass by loosening clip on top of glass and removing glass mounting screws.

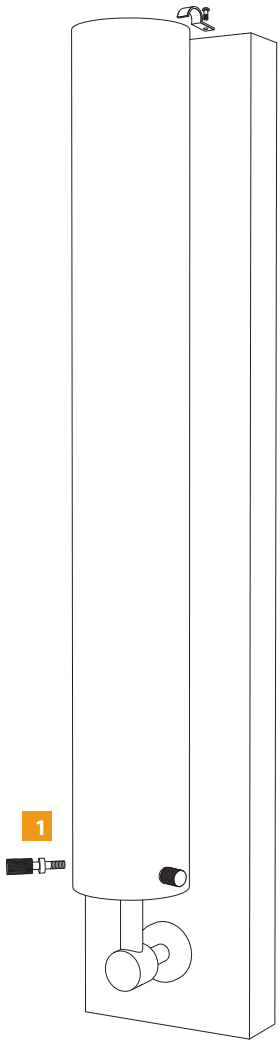

- 2 Hold backplate covering electrical box with two mounting holes just above electrical box, and with nipple through center hole.
- 3 Mark with a sharp pencil holes for backplate mounting of anchors positions.

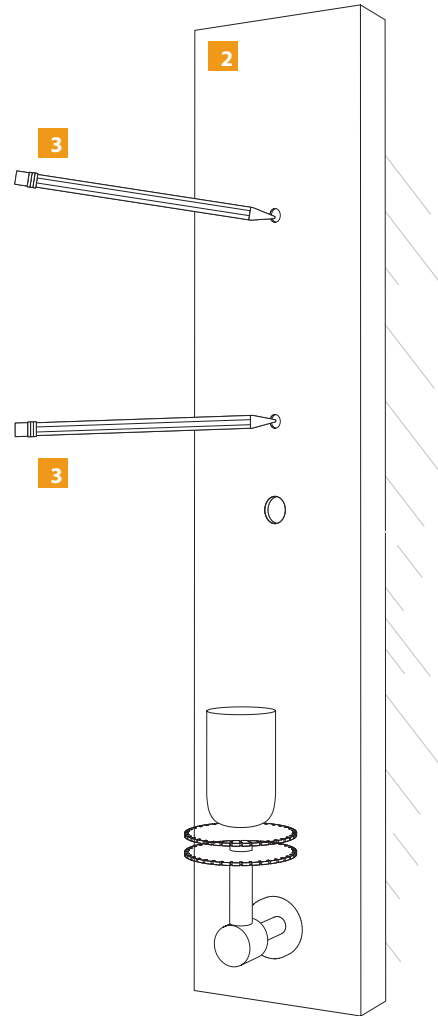

- 4 Screw in provided heavy duty Self tapping EZ anchors.

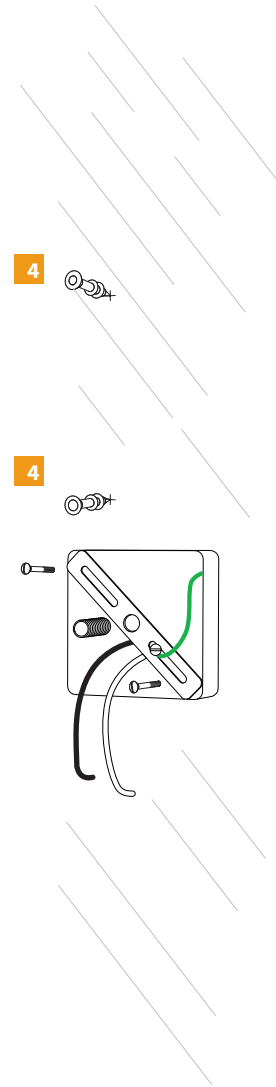

- 5 Mount crossbar and screw in nipple just enough to go through front of fixture backplate hole about 1/4".
- 6 Connect wires from fixture with provided wire nuts to electrical box.

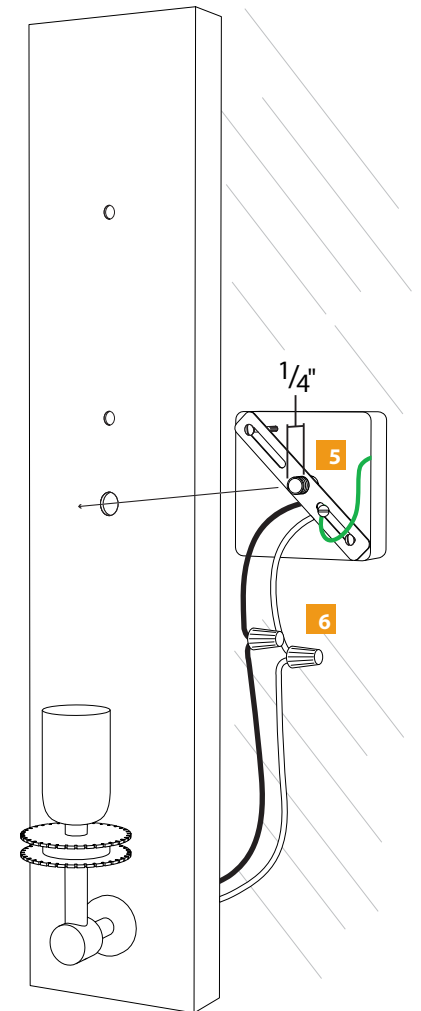

Installation instructions for Regis WS238

SAVE THESE INSTRUCTIONS
This product is ETL listed and suitable only for indoor dry locations
and approved for use at any height above the finished floor.

stone
LIGHTING

7 Hold up backplate. Make sure all wires are tucked into electrical box and fixture wireway secure with provided capnut.

8 Match up mounting holes.

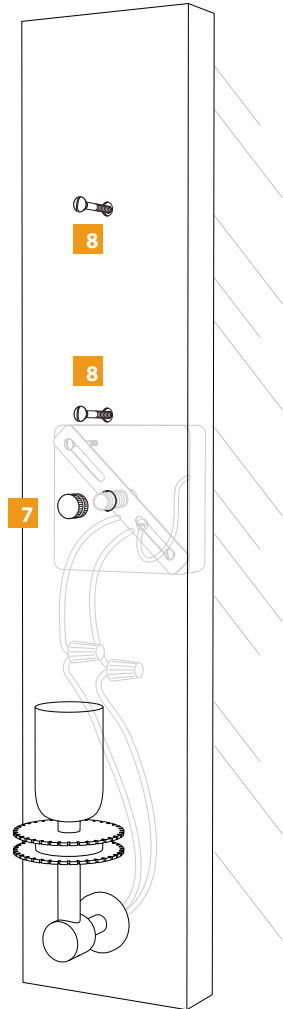

9 Screw in provided screws into anchors, DO NOT OVER TIGHTEN. Just flush and snug tight is necessary.



10 Install bulb in Socket.

11 Replace glass and pinch (only with fingers) the mounting clip on top of glass to tighten hold on glass.

