

MONORAIL

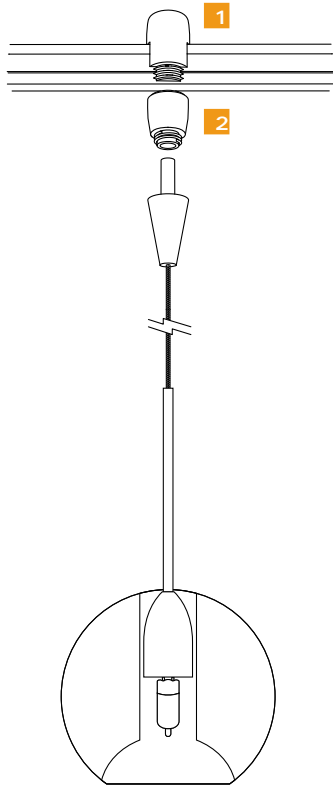

- 1 Monorail Adapter place "U" grooved part with male threads over monorail.
- 2 Raise bottom of monorail adapter with female threads mating with "U" part male threads.
- 3 Rotate clockwise till tight.
- 4 Be careful not to cross-thread when tightening.

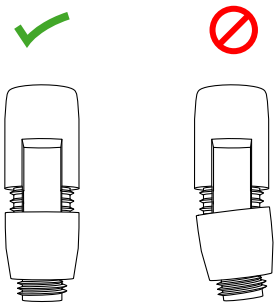

CABLE

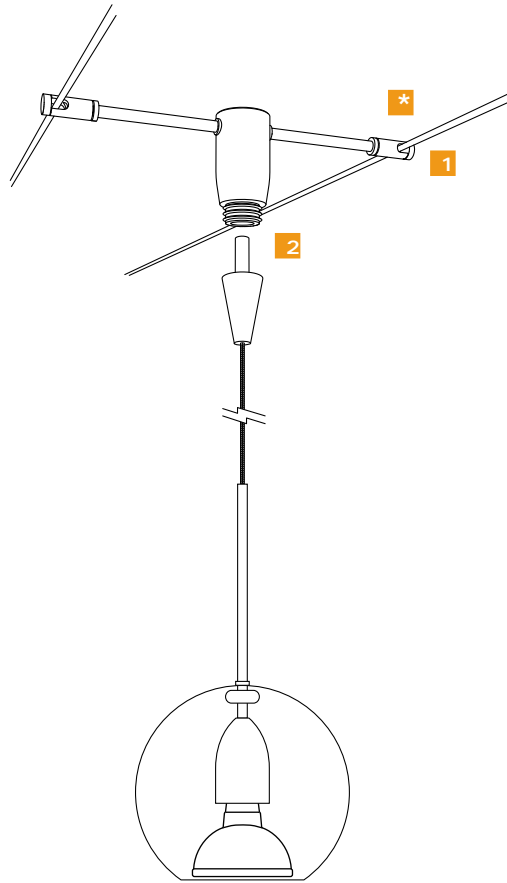

- 1 Strip insulated Cable approx. 1/4" with sharp knife, make sure to not cut cable metal stranding, install EZ Jack Cable Adapter by loosening thumb screws, removing them. Place adapter ends over the stripped cable area, tighten thumbscrews into their threaded holes.
- 2 Raise pendant to mate with male threads, rotate clockwise till tight. Be careful not to cross-thread when tightening.

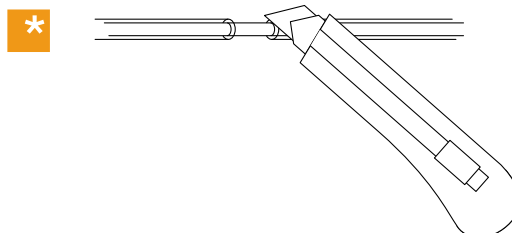

MONOPOINT

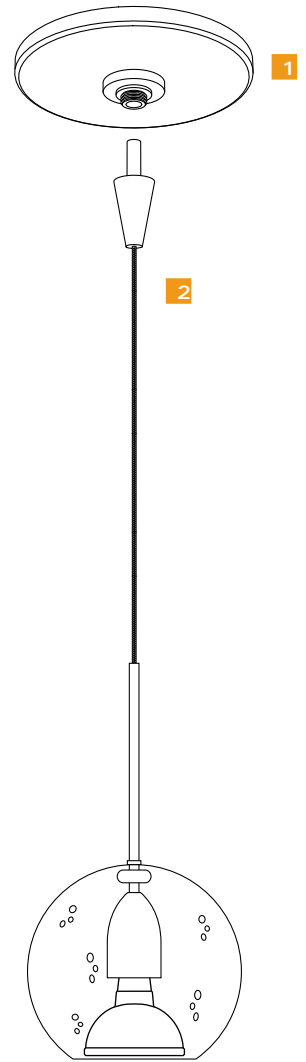

- 1 Mount monopoint canopy per enclosed instructions.
- 2 Raise pendant to mate with male threads, rotate clockwise till tight. Be careful not to cross-thread when tightening.

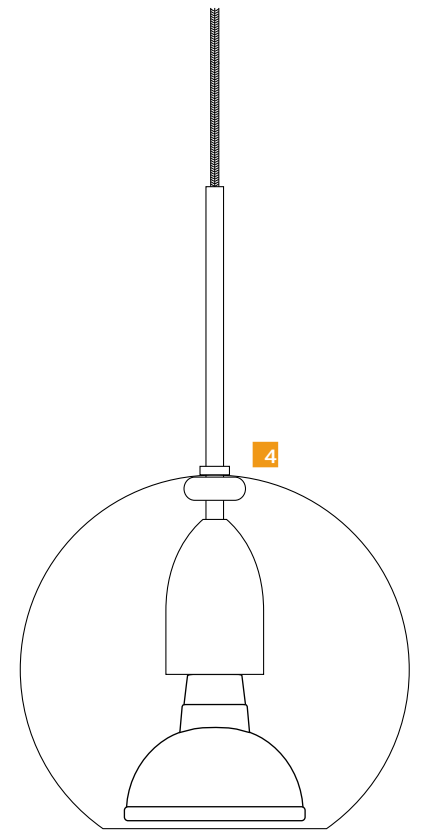
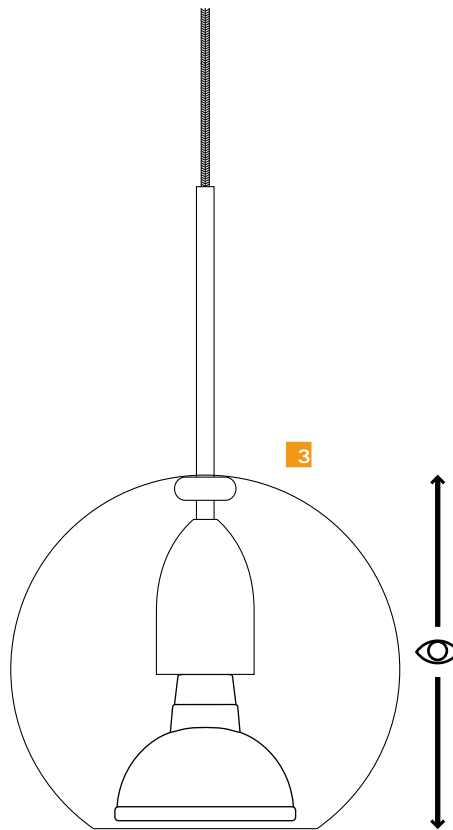
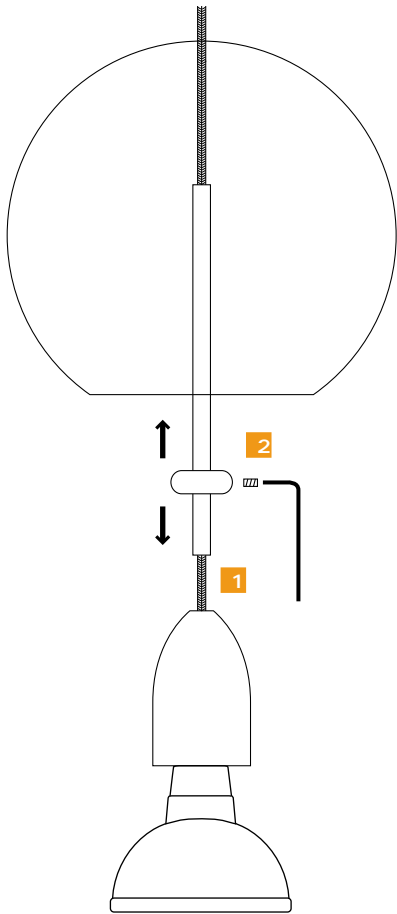

**1** Insert coaxial cable through stem as shown.

**2** adjustable ring with hex key set screw height should be adjusted with stem inserted into top of socket holder and MR16 installed.

**3** Height is determined by visually leveling bottom of MR16 with bottom of (PD116 or PD177 only).

**4** Finish top of glass with small flat washer.

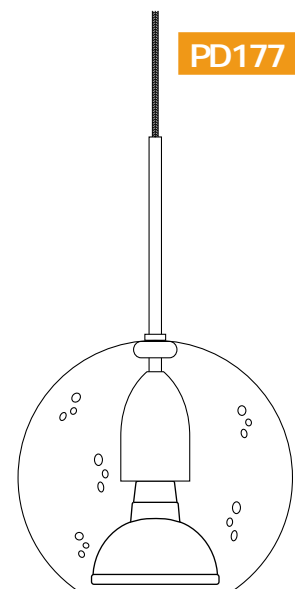
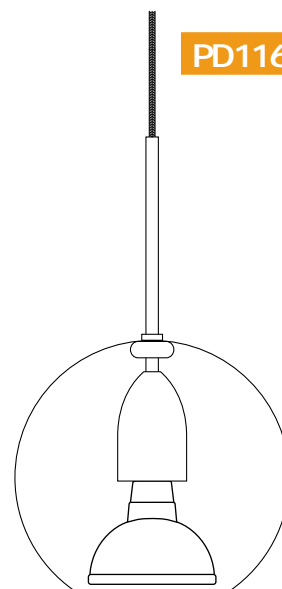
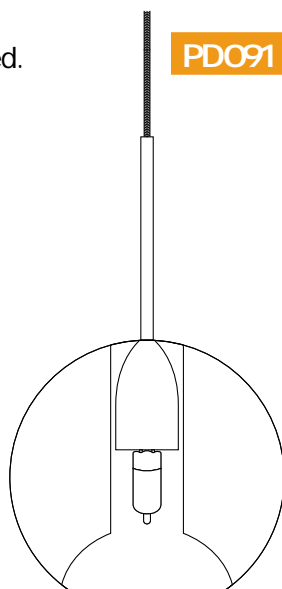

ADJUST THE FIXTURE HEIGHT

- 1 Cut the coaxial cable to the desired length with a sharp cutter. The overall fixture height (H) is measured from bottom of the glass shade to end of the coaxial cable.

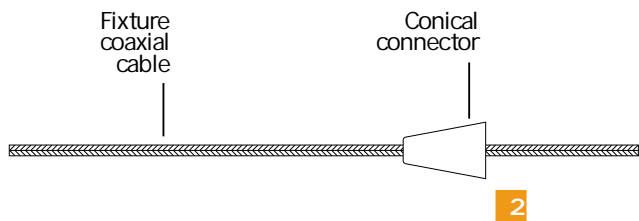
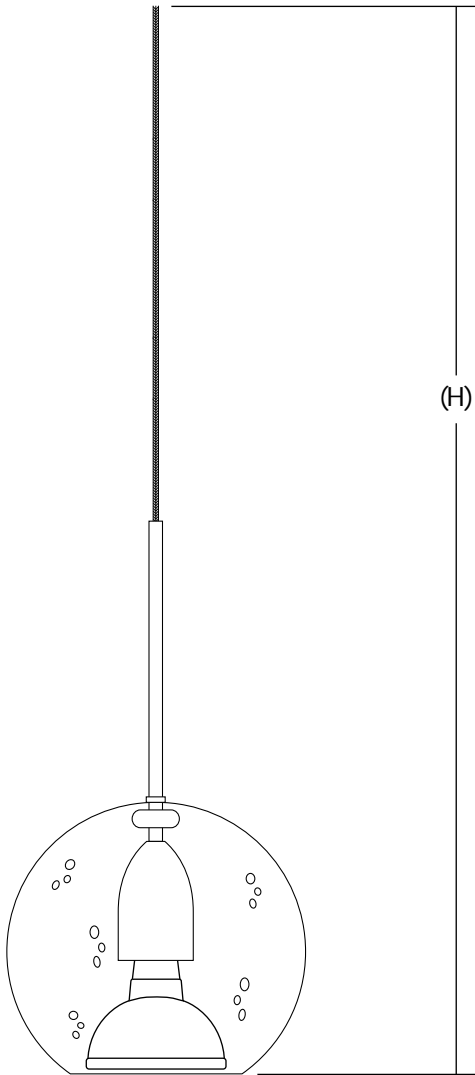

- 2 Insert the fixture coaxial cable through the conical connector



- 3 Insert the coaxial cable through the flared end of the strain relief.

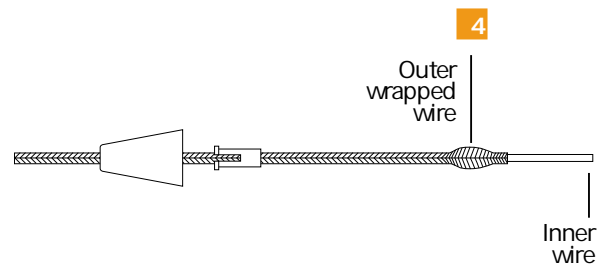

- 4 Slide the outer wrapped wire back to expose the inner wire.

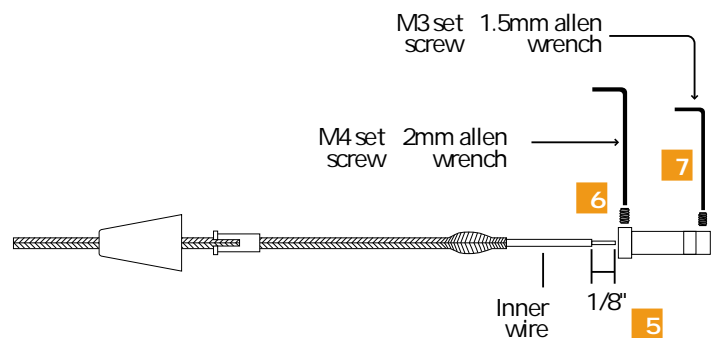

- 5 Strip 1/8" from end of the inner wire. Make sure that the stripped portion is not greater than 3/16".
- 6 Loosen (Do Not Remove) the M4 set screw with the provided 2mm Allen wrench.
- 7 Remove the M3 set screw with the provided 1.5mm Allen wrench.

